

N 99,803.743
E 94,006.256
Elev 171.219

Axis 327° 43' 03" A

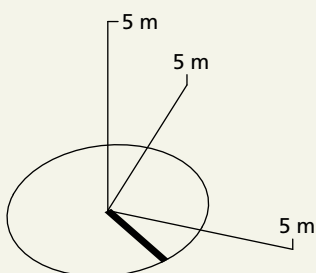
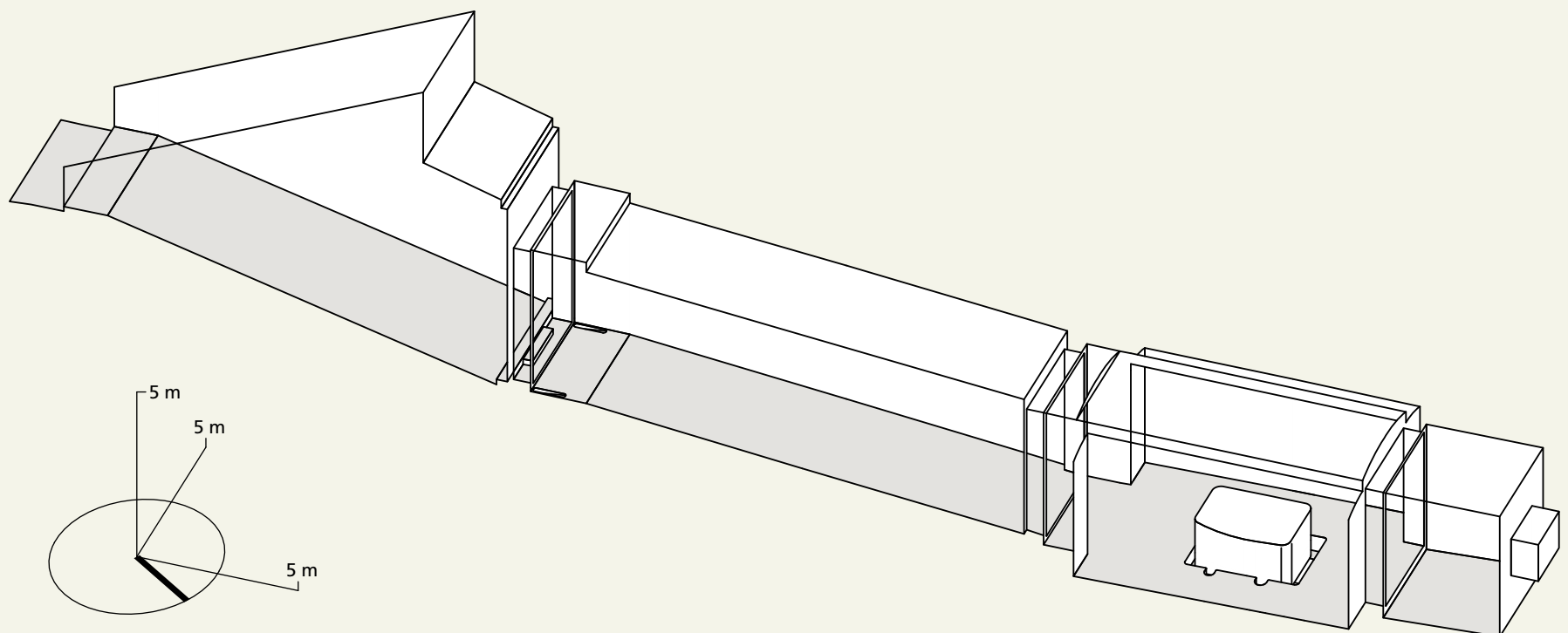
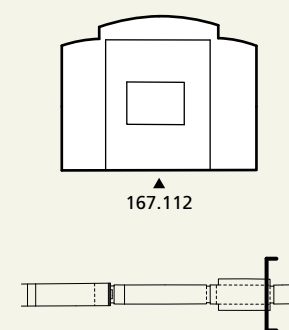
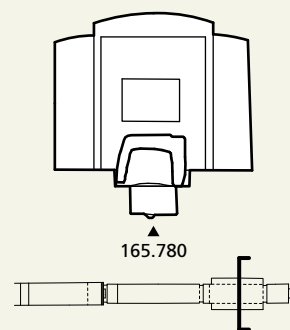
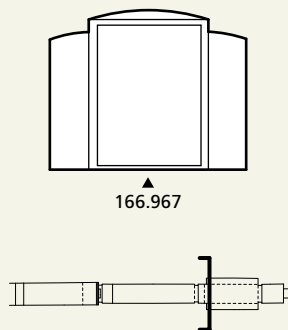
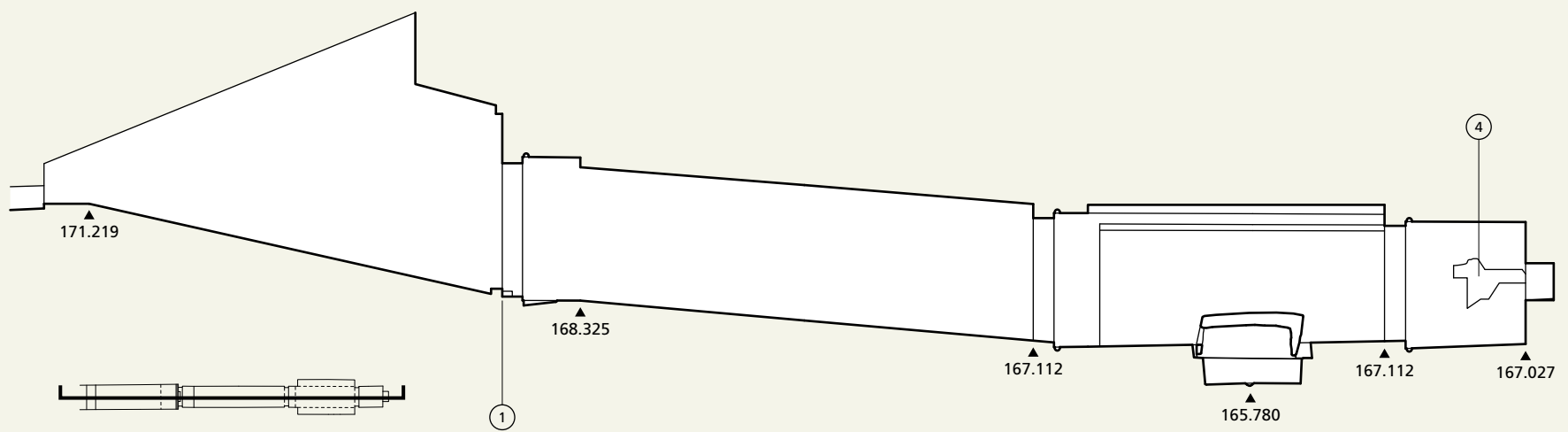
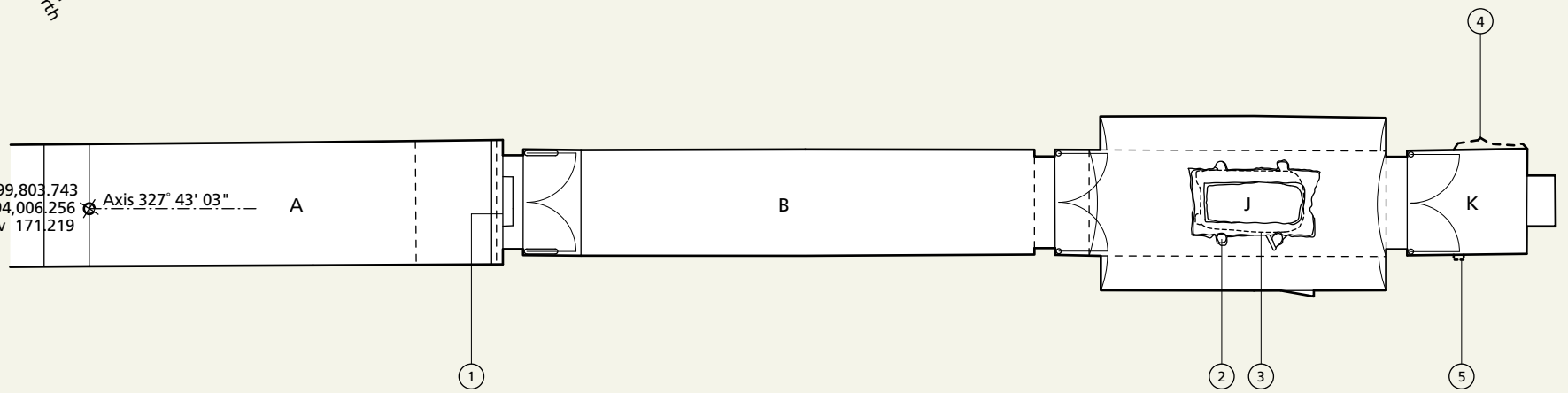

NOTES

- | | |
|---|--|
| 1 | Modern steps at tomb entrance. |
| 2 | Canopic jar emplacement. |
| 3 | Outline of sarcophagus above pit. |
| 4 | Beam slot in wall, with broken edges. Recently filled in. |
| 5 | Beam hole in wall covered with ancient painted plaster. Dimensions and location approximate. |